

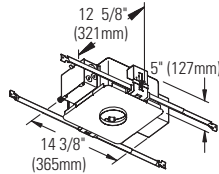

Calculite® Evolution Open Reflector Downlight **C3MRD**

Non-IC Frame:

- C3LV
- C3LVE1
- C3LVE2



Non-IC AirSeal Frame:

- C3ALV
- C3ALVE1
- C3ALVE2

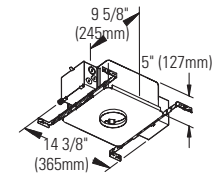

IC AirSeal Frame:

- C3AICLV
- C3AICLVE1

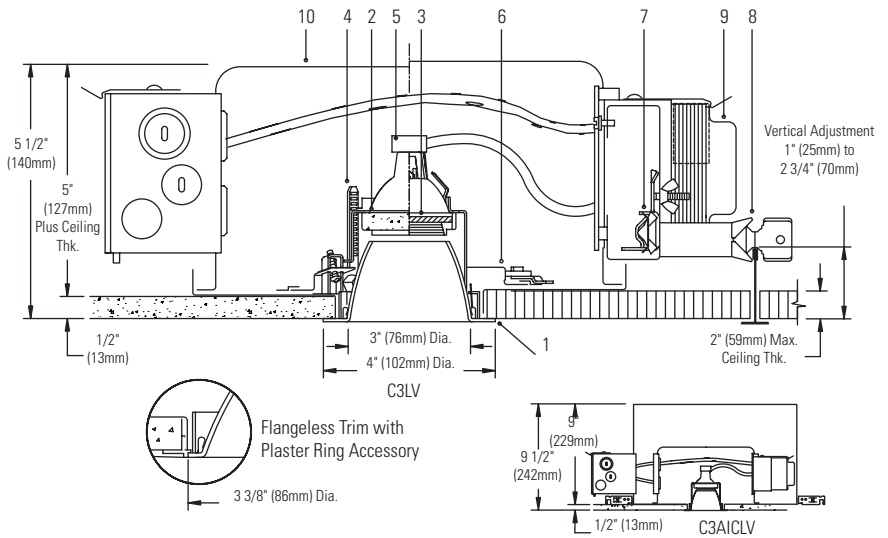
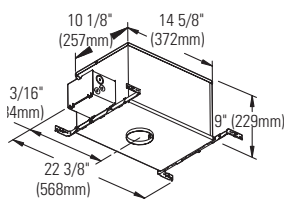

Ceiling Cutout: 3 1/2" (130mm) Dia.

For Complete Fixture Order: Trim Kit + Frame-In Kit. Each Sold Separately.

Trim Kit	Frame-In Kit			Lamp*			
Cone Finish	White Flange	Polished Flange	Flangeless	C3LV	Non-IC	Magnetic 120/277V	42W-65W MR16 (12V)
Clear	C3MRD CLW	C3MRD CLP	C3MRD CLFT	C3LVE1	Non-IC	Electronic 120V	20W-65W MR16 (12V)
Comfort Clear Diffuse	C3MRD CCDW	C3MRD CCDP	C3MRD CCDF	C3LVE2	Non-IC	Electronic 277V	20W-65W MR16 (12V)
Champagne Bronze	C3MRD CCZW	C3MRD CCZP	C3MRD CCZFT	C3ALV	Non-IC AirSeal®	Magnetic 120/277V	42W-65W MR16 (12V)
Gold	C3MRD GDW	C3MRD GDP	C3MRD GDFT	C3ALVE1	Non-IC AirSeal®	Electronic 120V	20W-65W MR16 (12V)
Matte White	C3MRD WHW	N/A	C3MRD WHFT	C3ALVE2	Non-IC AirSeal®	Electronic 277V	20W-65W MR16 (12V)
Specular Black	C3MRD BKW	C3MRD BKP	C3MRD BKFT	C3AICLV	IC AirSeal®	Magnetic 120V	20W-50W MR16 (12V)
				C3AICLVE1	IC AirSeal®	Electronic 120V	20W-50W MR16 (12V)

Note: Magnetic not recommended for residential or noise sensitive areas.

Features

- 1. Trim Kit Aperture Cone:** Low brightness; 0.040" aluminum, anodized; 50° visual cut-off to lamp and lamp image. Hinged, and snaps on for easy tool-less installation. Self-flange in painted white or aperture matching polished flange. Flangeless trim used with Plaster Trim Ring accessory. Interchangeable with other 3" Evolution trims.
- 2. Lamp Support:** Die-form aluminum with knurled surface for easy gripping during relamping. Spring tension clips hold lamp and lens and allow fast snap-in, snap-out relamping. Matte black finish. Accepts up to two 2" diameter accessories.
- 3. Cover Glass:** High temperature, soft focus lens.
- 4. Thick Ceiling Ready Brackets:** Die-form steel, matte black finish. Adjust trim kit vertically to accommodate up to 2" thick ceiling, lockable.
- 5. Lampholder:** Procelain bi-pin socket. Pre-wired with No.18 AWG Teflon leads.
- 6. Horizontal Adjustment Mechanism:** Built-in ready for adjustable trim, matte black finish.
- 7. Frame Vertical Adjustment Mechanism (C3LV):** Accommodates mounting to virtually any ceiling system using pre-installed mounting bars, or 1/2" EMT tubing (by others). Single locking features secures all adjustments. Alignment holes and markings allow fixture to be pre-set prior to installation. Final adjustment can be made from below inside fixture.
- 8. Mounting Bars (C3LV):** Galvanized steel, 0.048"; pre-installed telescoping bars extend from 20" to 30" long and lock securely into position. Built-in locking tabs provide positive attachment to common T-bar systems. Self-centering feature simplified installation in 24"O.C. grid systems. Attaches to steel or wood joists without accessories.
- 9. Transformer:** Replaceable from below. Magnetic: 120V/277V 60 Hz. dual-voltage, core & coil. **Note:** Magnetic not recommended for residential or noise sensitive areas. Electronic: 120V or 277V 50/60 Hz., regulated lamp voltage, HPF, EMI and circuit protections, thermal auto-reset, quiet operation.

10. Frame-In Kit: See Frame-In Kit specification sheets for more information. Non-IC and Non-IC AirSeal - Insulation must be kept 3" away from any parts of the luminaire and must not be placed above luminaire in a manner which will entrap heat. IC AirSeal - Luminaire may be in direct contact with thermal insulation.

Options and Accessories

- 2" dia. Color Filters/Specialty filters:** See ADF2/AF2 specification sheets
- 2" Dia. Louver:** AL2HC
- Plaster Trim Ring (use with flangeless trim):** CA3FMR
- Chicago Plenum:** Consult Factory

Labels

U.L. (Suitable For Damp Locations), I.B.E.W.; U.S. & Foreign Patents Pending
 *Lamp wattage restriction for Non-IC: 65W for up to 1" thick ceiling, 50W for ceiling thickness greater than 1" (up to 2").

Job Information	Type:
Job Name:	
Cat. No.:	
Lamp(s):	
Notes:	

Lightolier a Genlyte company www.lightolier.com
 631 Airport Road, Fall River, MA 02720 • (508) 679-8131 • Fax (508) 674-4710
 We reserve the right to change details of design, materials and finish.
 © 2007 Genlyte Group LLC • E1107



Calculite® Evolution Open Reflector Downlight **C3MRD**

37W MR16 IR - 40° FLOOD SYLVANIA HALOGEN LAMP, LUMEN RATING = 840 LMS, 120V ELECTRONIC TRANSFORMER

CL
Reflector
Finish

CANDLEPOWER DISTRIBUTION

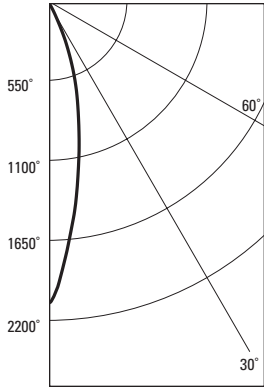

ANGLE LUMENS	MEAN CP
0	2084
5	1685
10	1228
15	839
20	543
25	280
30	107
35	40
40	10
45	0
50	0
55	0
60	0
65	0
70	0
75	0
80	0
85	0
90	0

LUMINANCE SUMMARY CD. / SQ. M.	
ANGLE	MEAN CD/SQ M
45	0
55	0
65	0
75	0
85	0

ZONAL LUMENS AND PERCENTAGES			
ZONE	LUMENS	% LAMP	% LUMINAIRE
0-30	543	64.75	94.30
0-40	574	68.44	99.67
0-60	576	68.67	100.00
0-90	576	68.67	100.00
40-90	1	0.23	0.33
60-90	0	0.00	0.00
90-180	0	0.00	0.00
0-180	576	68.67	100.00

Coefficients of Utilization

CEILING	80%				70%		50%		30%		
	70	50	30	10	50	10	50	10	50	10	
WALL	Zonal Cavity Method - Effective Floor Cavity Reflectance = 20%										
RCR	Zonal Cavity Method - Effective Floor Cavity Reflectance = 20%										
0	.82	.82	.82	.82	.80	.80	.76	.76	.73	.73	.69
1	.80	.78	.77	.76	.77	.75	.74	.73	.72	.71	.67
2	.77	.75	.74	.72	.74	.71	.72	.70	.70	.68	.66
3	.75	.73	.71	.69	.72	.69	.70	.68	.69	.66	.65
4	.74	.71	.68	.67	.70	.66	.69	.65	.67	.65	.63
5	.72	.68	.66	.64	.68	.64	.67	.63	.66	.63	.62
6	.70	.67	.64	.63	.66	.62	.65	.62	.64	.61	.61
7	.68	.65	.62	.61	.64	.60	.64	.60	.63	.60	.59
8	.67	.63	.61	.59	.62	.59	.62	.59	.61	.58	.58
9	.65	.61	.59	.57	.61	.57	.61	.57	.60	.57	.56
10	.64	.60	.58	.56	.60	.56	.59	.56	.59	.56	.55

** EFFICIENCY = 68.7% **
SC = .4

CERTIFIED TEST REPORT NO. 2741FR DATE: SEPT 24, 2004
COMPUTED BY LSI PROGRAM **TEST-LITE**

LUMINAIRE INPUT WATTS = 38

50W MR16 IR - 40° FLOOD GE HALOGEN LAMP, LUMEN RATING = 800 LMS, 120V ELECTRONIC TRANSFORMER

CL
Reflector
Finish

CANDLEPOWER DISTRIBUTION

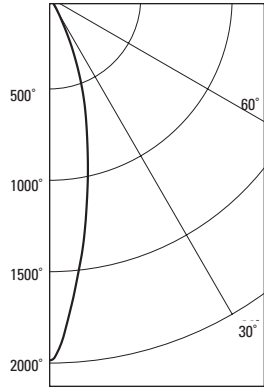

ANGLE LUMENS	MEAN CP
0	1985
5	1605
10	1170
15	799
20	518
25	266
30	102
35	38
40	9
45	0
50	0
55	0
60	0
65	0
70	0
75	0
80	0
85	0
90	0

LUMINANCE SUMMARY CD. / SQ. M.	
ANGLE	MEAN CD/SQ M
45	0
55	0
65	0
75	0
85	0

ZONAL LUMENS AND PERCENTAGES			
ZONE	LUMENS	% LAMP	% LUMINAIRE
0-30	518	64.75	94.30
0-40	547	68.44	99.67
0-60	549	68.67	100.00
0-90	549	68.67	100.00
40-90	1	0.23	0.33
60-90	0	0.00	0.00
90-180	0	0.00	0.00
0-180	549	68.67	100.00

Coefficients of Utilization

CEILING	80%				70%		50%		30%		
	70	50	30	10	50	10	50	10	50	10	
WALL	Zonal Cavity Method - Effective Floor Cavity Reflectance = 20%										
RCR	Zonal Cavity Method - Effective Floor Cavity Reflectance = 20%										
0	.82	.82	.82	.82	.80	.80	.76	.76	.73	.73	.69
1	.80	.78	.77	.76	.77	.75	.74	.73	.72	.71	.67
2	.77	.75	.74	.72	.74	.71	.72	.70	.70	.68	.66
3	.75	.73	.71	.69	.72	.69	.70	.68	.69	.66	.65
4	.74	.71	.68	.67	.70	.66	.69	.65	.67	.65	.63
5	.72	.68	.66	.64	.68	.64	.67	.63	.66	.63	.62
6	.70	.67	.64	.63	.66	.62	.65	.62	.64	.61	.61
7	.68	.65	.62	.61	.64	.60	.64	.60	.63	.60	.59
8	.67	.63	.61	.59	.62	.59	.62	.59	.61	.58	.58
9	.65	.61	.59	.57	.61	.57	.61	.57	.60	.57	.56
10	.64	.60	.58	.56	.60	.56	.59	.56	.59	.56	.55

** EFFICIENCY = 68.7% **
SC = .4

CERTIFIED TEST REPORT NO. 2817FR DATE: NOV 12, 2004
COMPUTED BY LSI PROGRAM **TEST-LITE**

LUMINAIRE INPUT WATTS = 51

50W MR16 IR - 40° FLOOD SYLVANIA HALOGEN LAMP, LUMEN RATING = 1125 LMS, 120V ELECTRONIC TRANSFORMER

CANDLEPOWER DISTRIBUTION

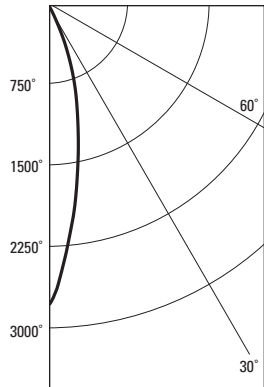

ANGLE LUMENS	MEAN CP
0	2792
5	2258
10	1646
15	1125
20	729
25	375
30	144
35	55
40	14
45	0
50	0
55	0
60	0
65	0
70	0
75	0
80	0
85	0
90	0

LUMINANCE SUMMARY CD. / SQ. M.	
ANGLE	MEAN CD/SQ M
45	0
55	0
65	0
75	0
85	0

ZONAL LUMENS AND PERCENTAGES			
ZONE	LUMENS	% LAMP	% LUMINAIRE
0-30	729	64.82	94.21
0-40	771	68.56	99.65
0-60	774	68.80	100.00
0-90	774	68.80	100.00
40-90	2	0.24	0.35
60-90	0	0.00	0.00
90-180	0	0.00	0.00
0-180	774	68.80	100.00

Coefficients of Utilization

CEILING	80%				70%		50%		30%		
	70	50	30	10	50	10	50	10	50	10	
WALL	Zonal Cavity Method - Effective Floor Cavity Reflectance = 20%										
RCR	Zonal Cavity Method - Effective Floor Cavity Reflectance = 20%										
0	.82	.82	.82	.82	.80	.80	.76	.76	.73	.73	.69
1	.80	.78	.77	.76	.77	.75	.74	.73	.72	.71	.67
2	.77	.75	.74	.72	.74	.71	.72	.70	.70	.68	.66
3	.75	.73	.71	.69	.72	.69	.70	.68	.69	.66	.65
4	.74	.71	.68	.67	.70	.66	.69	.65	.67	.65	.63
5	.72	.68	.66	.64	.68	.64	.67	.63	.66	.63	.62
6	.70	.67	.64	.63	.66	.62	.65	.62	.64	.61	.61
7	.68	.65	.62	.61	.64	.60	.64	.60	.63	.60	.59
8	.67	.63	.61	.59	.62	.59	.62	.59	.61	.58	.58
9	.65	.61	.59	.57	.61	.57	.61	.57	.60	.57	.56
10	.64	.60	.58	.56	.60	.56	.59	.56	.59	.56	.55

** EFFICIENCY = 68.8% **
SC = .4

CERTIFIED TEST REPORT NO. 2629FR DATE: MAY 12, 2004
COMPUTED BY LSI PROGRAM **TEST-LITE**

LUMINAIRE INPUT WATTS = 51

Job Information

Type:

Lightolier a Genlyte company

www.lightolier.com

631 Airport Road, Fall River, MA 02720 • (508) 679-8131 • Fax (508) 674-4710

We reserve the right to change details of design, materials and finish.

© 2007 Genlyte Group LLC • E1107